

INSTALLATION AND OPERATING INSTRUCTIONS

OIL BURNING UNIT HEATER COMMERCIAL-INDUSTRIAL

-PSG 6500 SERIES-

CERTIFIED WARNOCK HERSEY BY INTERTEK TESTING SERVICES
ACCORDING TO CSA-B140.4-1974 (R1998) / UL731-1995 & CSA-
B140.0-M87

CAUTION

CAUTION

EXPLOSION OR FIRE HAZARD.
FOR YOUR SAFETY: DO NOT
STORE OR USE GASOLINE OR
FLAMMABLE VAPORS OR
LIQUIDS IN THE VICINITY OF
THIS UNIT HEATER.

DO NOT ATTEMPT TO LIGHT
THE BURNER WHEN EXCESS OIL
HAS ACCUMULATED, WHEN THE
APPLIANCE IS FULL OF VAPOR
OR WHEN THE COMBUSTION
CHAMBER IS VERY HOT.

WARNING

CAUTION

PSG 6500 SERIES OIL BURNING
UNIT HEATER MUST BE
CONNECTED TO A CHIMNEY
WHICH WILL PROVIDE AT ALL
TIME ADEQUATE DRAUGHT TO
ENSURE A PROPER AND SAFE
OPERATION OF THE BURNER.

ALWAYS KEEP THE VALVE SHUT
IF THE BURNER IS OFF FOR A
LONG PERIOD OF TIME. DO NOT
ATTEMPT TO ADJUST OR
REPAIR THE APPLIANCE OR ITS
CONTROLS. CALL A QUALIFIED
SERVICE TECHNICIAN.

NEVER BURN WASTES OR PAPER IN THE APPLIANCE.
DO NOT LEAVE PAPER OR ANY FLAMMABLE
MATERIAL AROUND THE APPLIANCE.

TABLE OF CONTENTS

GENERAL NOTES	3
1. DRAUGHT AND CHIMNEY	3
2. DIRECT VENT (optional)	3
3. OIL TANK AND PIPING	3
4. APPLIANCE INSTALLATION	4
A- Locating the unit	4
B- Clearances to combustible materials.....	5
C- Positioning the appliance	6
D- Connector and flue damper (with chimney)	6
-Single installation	6
-Double installation on the same chimney	7
E- Direct-vent installation (option).....	8
F- Combustion air (with chimney).....	14
G- Electrical wiring.....	15
H- Thermostat	15
I- Louvers adjustment	15
J- Fan control	16
K- Combustion safety control.....	16
L- Combustion adjustment and verification	17
M- Electrodes setting	18
5. START-UP	18
6. PROLONGED CLOSING	19
7. MAINTENANCE	19
8. WIRING DIAGRAM	24
9. SPECIFICATIONS	25
10. WARRANTY	26

GENERAL NOTES

INSTALLATION OF THIS APPLIANCE MUST BE PERFORMED IN ACCORDANCE WITH THE REGULATIONS OF AUTHORITIES HAVING JURISDICTION, AS WELL AS THE CAN/CSA-B139-M91, NFPA-31-1912 STANDARD AND THE "OIL BURNING EQUIPMENT" (NATIONAL FIRE CODE VOL. 1-1989), CONCERNING THE INSTALLATION OF OIL BURNING HEATING UNITS.

The "PSG 6500 SERIES " Industrial type, allows two different installations : either with a chimney (standard) or a direct-vent (option). These appliances are not approved for use with fuel heavier than oil No.2 (furnace). Do not use gasoline, crankcase oil or any oil containing gasoline.

1- DRAUGHT AND CHIMNEY (PSG 6500 SERIES with chimney)

The chimney must conform to the regulations of authorities having jurisdiction and the CAN/CSA-B139-M91 and NFPA-31 standard concerning the installation of oil burning units. The 5" barometric damper provided with the appliance must be installed on the chimney flue in order to regulate the draught between 0.02" and 0.04" w.c. (see details in section 4 – **Appliance installation; D-Connector and flue damper**).

2- DIRECT VENT (optional)

The direct-vent is a combustion gas evacuation system which can replace a conventional chimney. The direct-vent is easy to install and increases the appliance efficiency (see details in section 4 – Appliance installation; E-Direct-vent installation (option). Furthermore, an air pressure detection system ensures a safe operation at all time (example: obstructed outlet, excessive wind, etc.).

3- OIL TANK AND PIPING

The oil tank must be located at least 7 feet from the burner. Reference: CAN/CSA-B139-M91 and NFPA-31 standard. Local codes will govern the size of the air inlets and the type of plugs to be used. 1 ¼ " IPS and 2" IPS are generally accepted as minimum dimensions for the air intake pipes and fill pipes respectively. The pipe which brings the oil to the burner must be a copper tubing and the outside diameter shall not be less than 3/8 inch for runs 50 feet or less, and ½ inch o.d. for longer runs. A manual shut-off valve and an oil filter shall follow in sequence from tank to burner.

The oil line should not be buried and should be protected from mechanical damage.

BURNER PUMP

The burner is equipped with a single stage pump. When the pump is connected to a single feeder pipe, a max. rise of 8 feet high is allowed. This height is measured from the tank outlet level to the burner inlet height.

When the rise is more than 8 feet and less than 10 feet, an oil return pipe must be installed and a by-pass plug inserted in the pump (provided with the burner). **For more details see "Installation information" Part No. 21844 on the burner pump.**

If the rise is higher than 10 feet, a two stage pump is required along with an oil return pipe.

4- APPLIANCE INSTALLATION

WARNING : An improper installation of the unit may cause a fire. For your safety, you must follow the instructions in this manual or consult the authorities having jurisdiction.

WARNING : Do not store flammable liquids (gasoline or else) or combustible material in the vicinity of the heating unit.

WARNING :

- This appliance is not to be installed in mobile homes.
- This appliance cannot be connected to any existing heat distribution pipe. Doing so would void the warranty.

A- LOCATING THE UNIT :

Choose the more convenient corner in the room and position the unit in order to create air circulation around the room. Do not place objects around the unit which could block air circulation.

➔ ***THIS APPLIANCE HAS BEEN DESIGNED FOR CEILING INSTALLATION APPLICATION.***

PSG 6500 SERIES with chimney

Locate the appliance as closely as possible to the chimney, providing ample clearance to permit easy cleaning of the unit. The chimney diameter must be constant all the way.

PSG 6500 SERIES with direct-vent or without chimney

Locate the appliance as closely as possible to the direct-vent providing ample clearance to permit easy cleaning of the unit.

B- CLEARANCES TO COMBUSTIBLE MATERIALS

Top, sides, bottom	6"
Rear	24" (Including cleaning clearance)

CLEARANCES

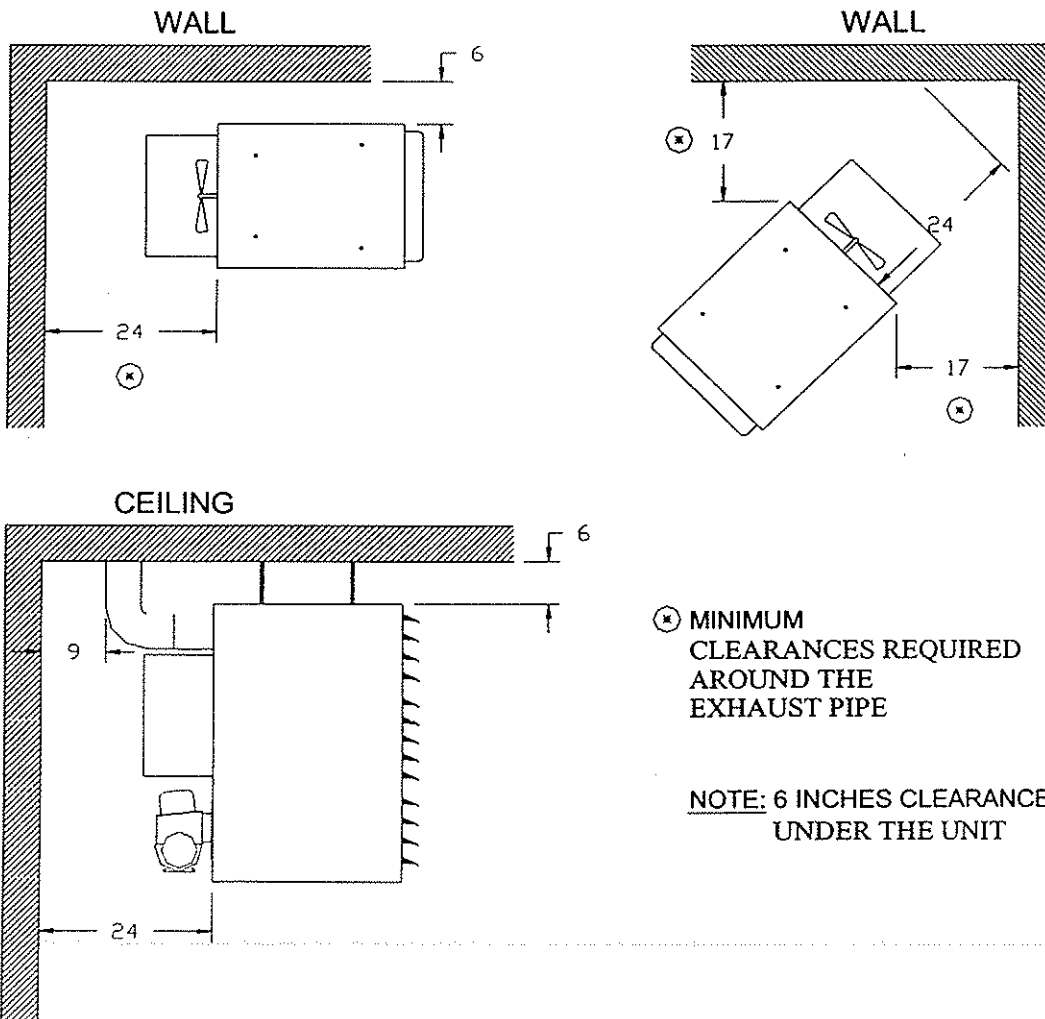

C- POSITIONNING THE UNIT

For a proper operation, the appliance must be levelled in both directions using the four fasteners on the top of the appliance. The four fasteners are 3" high and the eyelets diameter is 7/8".



N.B. This appliance can be installed on a non combustible square support. A 6" clearance is required under the unit.

D- CONNECTOR AND FLUE DAMPER (with chimney)

SINGLE INSTALLATION

The connecting pipe from the appliance to the chimney should be short and as straight as possible. The draught regulator (usually called barometric damper) is supplied with appliance and must be installed in a straight length of pipe no more than 18" from the unit exit pipe. (see detail 1 and detail 2, page 7). The draught measured between the appliance and the draught regulator must be adjusted between 0.02" and 0.04" w.c. The 5" chimney diameter must be constant for the entire run.

N.B. The appliance may be connected to any type of chimney including L-Vent type.

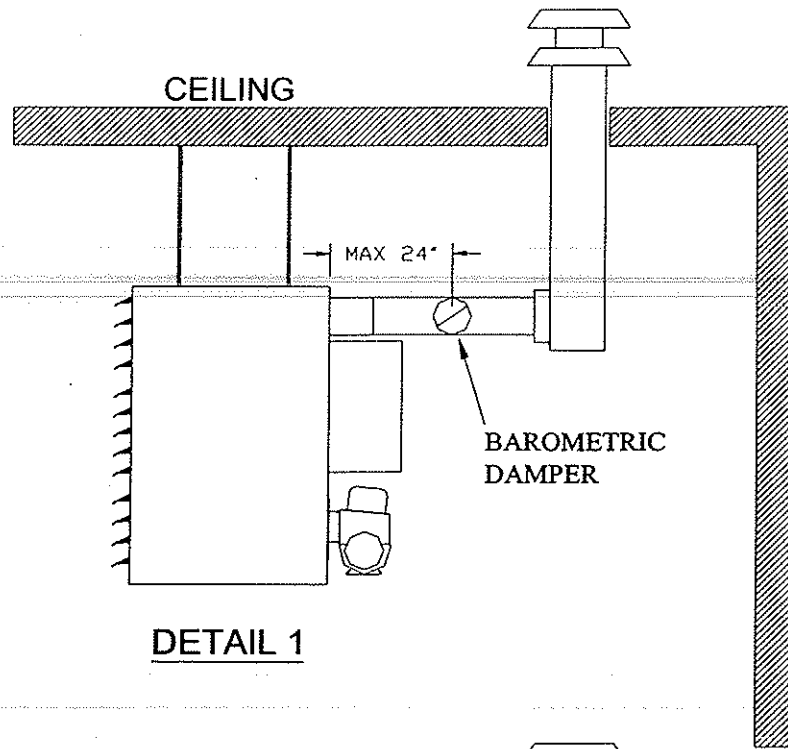

DETAIL 1

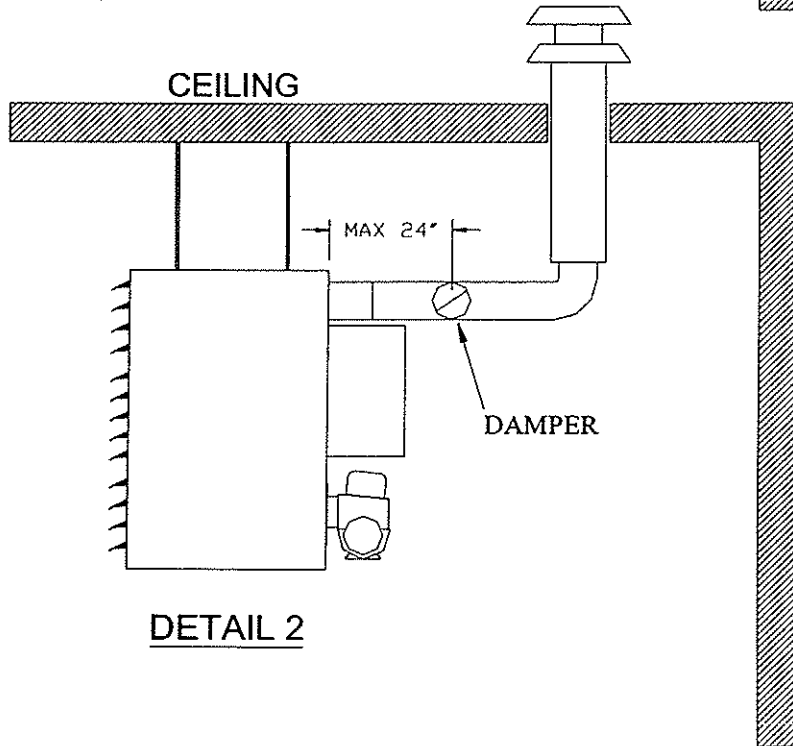

DETAIL 2

DOUBLE INSTALLATION ON THE SAME CHIMNEY

A maximum of two units can be connected on the same chimney having a larger diameter.

2 PSG 6500 SERIES unit heaters = 12" 6"

E- DIRECT-VENT INSTALLATION (option)

The direct-vent option is a combustion gas evacuation system which can replace a conventional chimney. Position the appliance as closely as possible to the direct-vent providing enough space to allow easy accessibility for cleaning the unit.

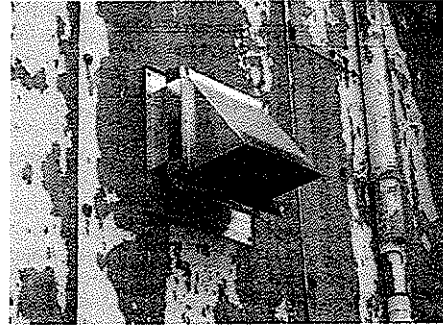
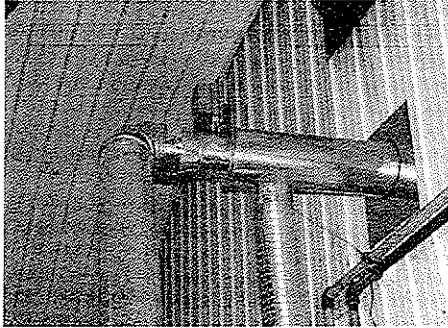

The direct-vent assembly includes :

- 1 pre-mounted direct-vent
- 12 screws, 2" long
- 1 pressure switch already adjusted supplied with a 24 feet long wire
- 2 finishing plates
- 1 observation door including (in mounting sequences) : 1 glass frame, 1 gasket, 1 high temperature glass, 1 gasket, 1 washer and 1 Allen screw 1/4-20 X 3/8

For easy installation, follow all the instructions below in the following order:

STEP #1

Wall opening :

Combustible materials: cut a 8" X 8" hole.

Non-combustible materials: cut a 6 1/2" diameter circular hole.

STEP #2

Direct-vent installation :

Combustible materials (if 8" X 8" opening) : remove the pre-mounted pressure switch support.

Non-combustible materials (if 6½" diameter opening) : remove the pre-mounted pressure switch support and remove the 4" diam. connector.



- After inserting the direct-vent through the wall, fix it from outside using the 4 screws supplied.

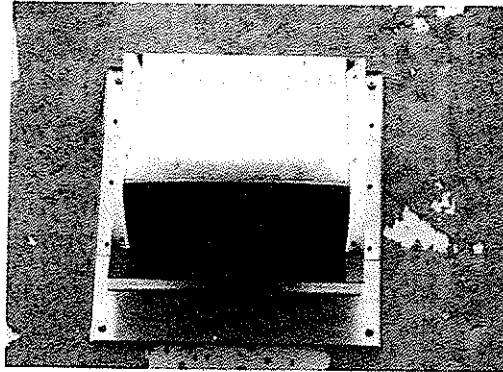

- Then, reinstall the pressure switch support as it was and the 4" diam. connector (if applicable).

STEP #3

Inside finishing :

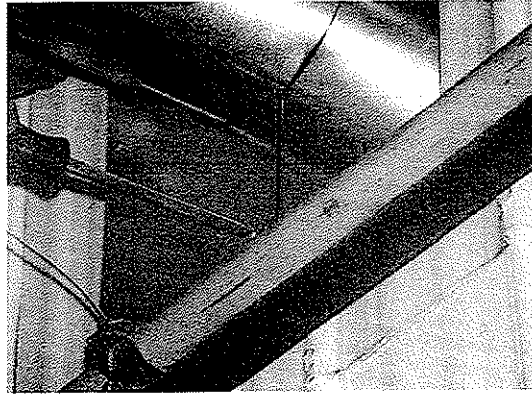

- Fix the two finishing plates using 8 screws so they overlap.

STEP #4

Pressure switch installation :

- Remove the 2 screws on top of the pre-mounted pressure switch support.
- Insert the pressure switch by the tube in the opening on the direct-vent pipe.

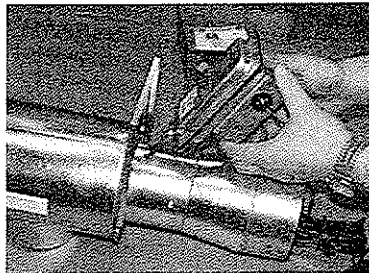
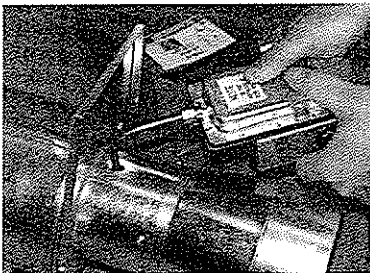

- Fix the pressure switch with the 2 screws previously removed.

- Make sure that the pressure switch tube is parallel to the direct-vent pipe.

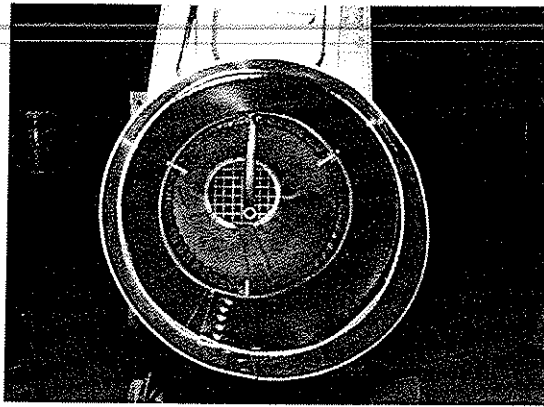

STEP #5

Pressure switch wiring:

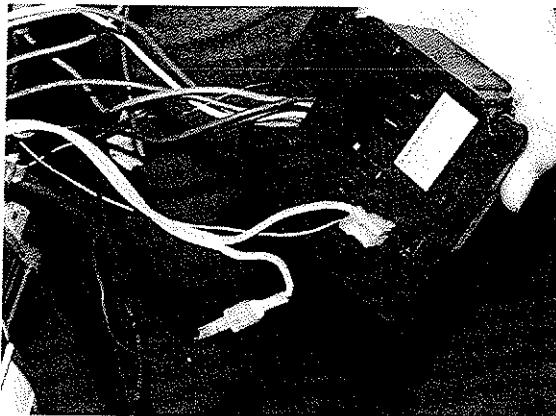

- Unscrew the burner primary control.
- Disconnect the right female terminal spade tag (Not 90°) of the yellow wire and connect it on the male terminal spade tag of the pressure switch wire.
- Connect the 90° terminal spade tag of the pressure switch on the cad cell.
- Reinstall the primary control on the burner.

N.B. The 24 feet double wire must be kept well away from any source of heat. Do not place the wire along the evacuation pipe of the appliance.

STEP #6

Observation door installation:

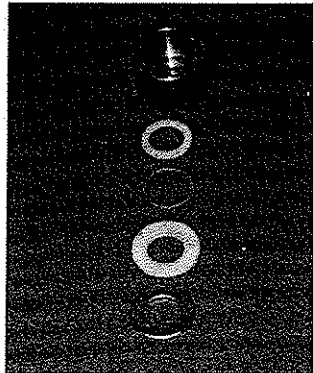

- Remove the original cap on the observation tube at the front of the appliance.

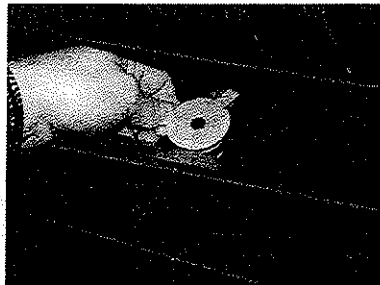

- Put the observation door on the observation tube.
- Tighten the Allen screw moderately.

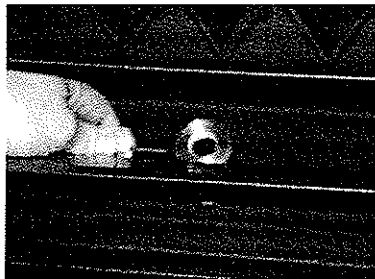

N.B. Because of the positive pressure in the combustion chamber, the observation door must be airtight.

INSTALLATION RESTRICTIONS

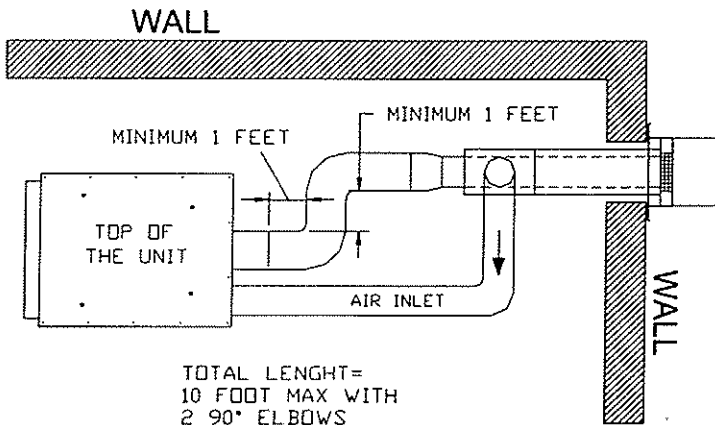
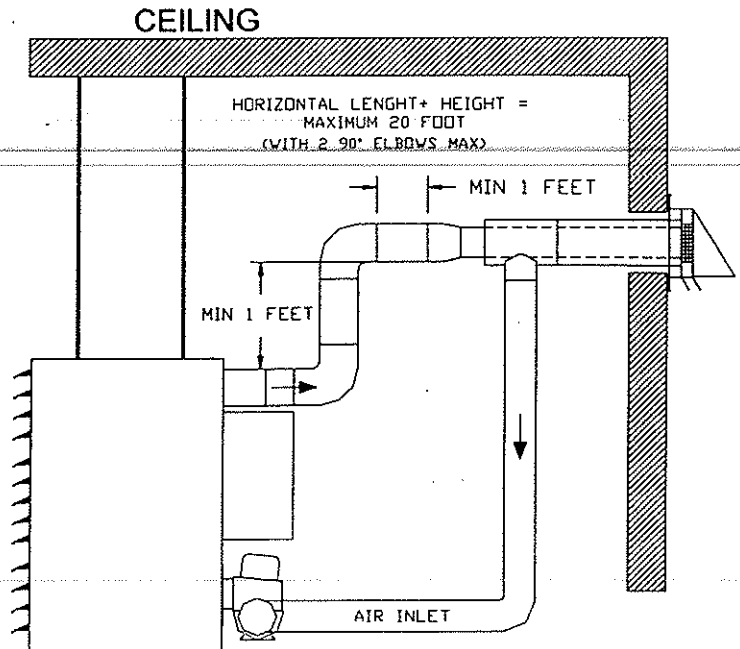
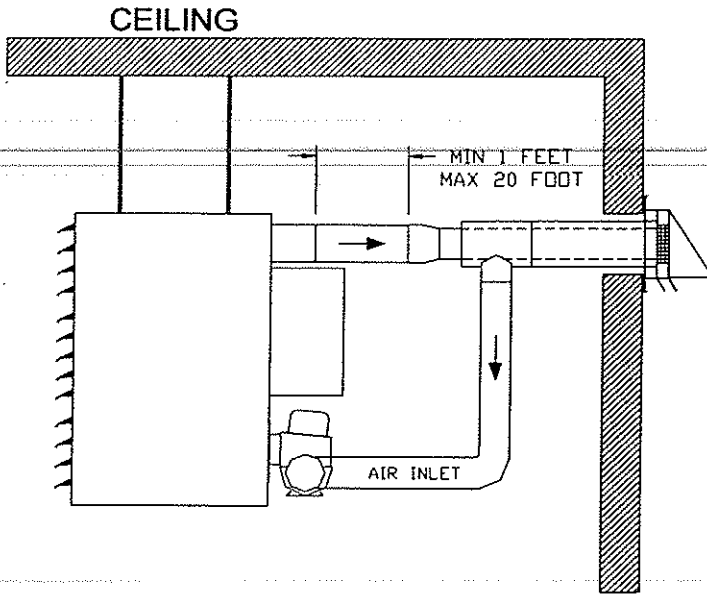

- THE OUTSIDE AIR KIT MUST ALWAYS BE CONNECTED, DISREGARDING THE TYPE OF INSTALLATION.
- THE SMOKE PIPE MUST HAVE A MINIMUM RISE OF 1/4" PER LINEAR FOOT.
- THE DIRECT VENT MUST NOT BE INSTALLED LOWER THAN THE APPLIANCE GAS OUTLET.

F- COMBUSTION AIR (with chimney)

1st solution (highly recommended)

The oil burner is provided with an outside air kit. You will have to install a 4" dia. pipe on the burner.

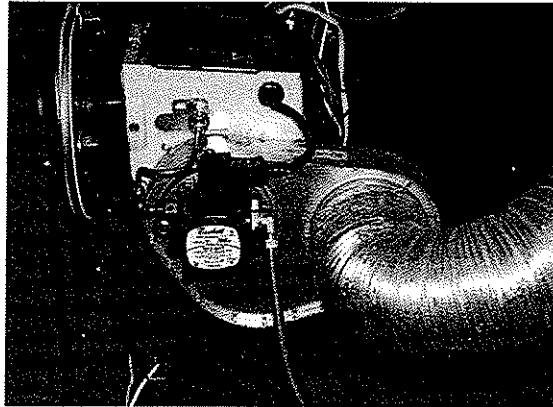

2nd solution

Have a minimum 4" dia. outside air inlet installed in the room where the heating appliance is installed or nearby (see illustration below). To do so, it is preferable to choose a wall which is not exposed to strong winds depending on the surrounding conditions.

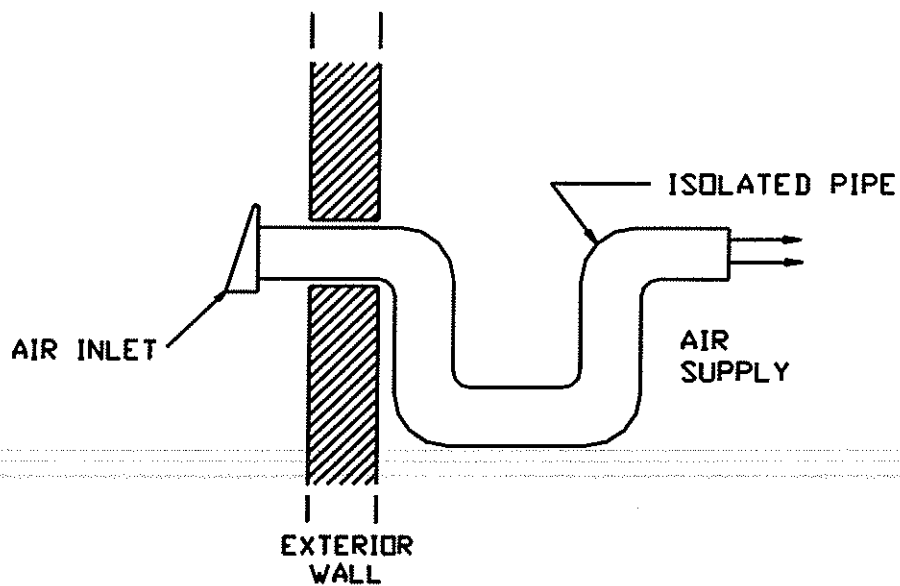

G- ELECTRIC WIRING

All wiring from the service panel to this heating unit shall comply with the current electrical code and all local regulations. A 120 VAC power supply must be available and a 15 amp circuit breaker must be installed. (See electric diagram page 24).

H- THERMOSTAT

The thermostat must be installed on an inside wall of the building and shall be located where it is not to be affected by the air draught coming from the unit fan. The thermostat must be installed at a minimum of 55" above the floor.

I- LOUVERS ADJUSTMENT

The 13 louvers adjustment should be done in 3 sections. In order to adjust each section, slightly loosen the respective wing nut and adjust the louvers at the angle desired. Then, tighten the wing nut to set the position of each section.

Note : Each group of louvers may be oriented separately.

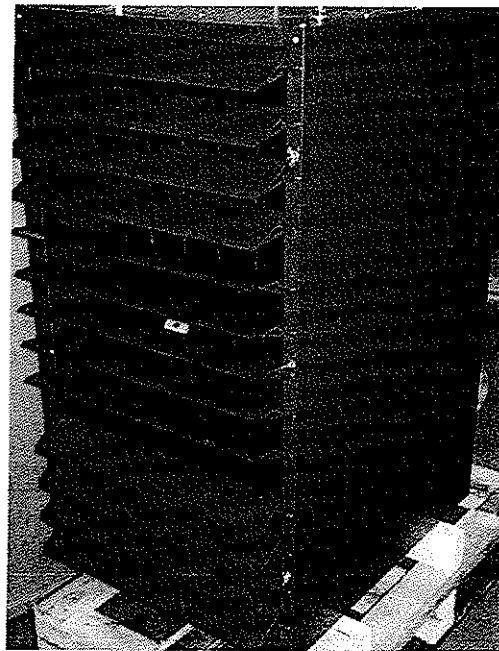

J- FAN CONTROL

The setting of the fan control will depend upon the particular house and heating installation. The "fan off" setting is factory set a 100 F. This setting should provide satisfactory operation for most installations. The "fan on" temperature is determined by the built-in differential setting of the control. It is desirable to have the "fan off" setting low enough for extended blower operation. However a "fan off" setting too low will circulate cool air. To alter the "fan off" setting, rotate the indicator to the desired position on the temperature scale.

Adjustment of all controls should only be made by a competent serviceman. Control setting and blower speed should be in accordance with the recommendations of the National Warm air Heating and air Conditioning Association.

During the summer, continuous air circulation can be obtained by pulling the manual fan switch from the "auto" position to the "manual or summer" position.

K- COMBUSTION SAFETY CONTROL

The oil burning burner is equipped with an electronic control (# R7184P1031) including a pre-purge and post-purge system.

PRE-PURGE

When a start-up is called, the ignition is engaged after a 15 seconds waiting time to permit a proper draught prior to the ignition in the combustion chamber.

POST-PURGE

When a shut down is called, the flame goes out while the burner fan keeps on evacuating combustion gas for a determined length of time according to 4 different selections (see instructions on the box of the burner primary control).

SAFE OPERATION

If the flame goes out while the burner is in function the control will pass to "RECYCLE" mode and stop feeding the burner for 60 seconds. After this delay, the control returns to lighting mode. If the flame goes out 3 times in a row, the control will stop completely to avoid a continuous cycle with repeated loss of flame causing a premature sooting of the appliance or piping. To disactivate this mode, you must press the red control button and hold it for 30 seconds. A warning light on the control will indicate the error occurring.

FOR FURTHER INFORMATIONS ON THE OPERATING SEQUENCES OF THE BURNER, SEE THE BURNER INSTRUCTION MANUAL.

L- COMBUSTION ADJUSTMENT AND VERIFICATION

To enjoy the efficiency of this oil burning unit heater, you must respect the following requirements :

PSG 6500 SERIES (with chimney)

- The draught above the fire must be between -0.01 inch and -0.02 inch w.c. according to the burner manufacturer instructions. The draught above the fire must be measured through the opening damper on the observation tube.
- The combustion air is to be adjusted so that the smoke density is between 0 and 1 in the Bacharach test scale.
- The flue gases should contain 9 ½% to 12% CO₂ when tested with combustion test equipment.
- The chimney draught shall be between -0.02 inch and -0.04 inch w.c. (measure 18" from the appliance gas evacuation outlet).

N.B. All those measurements must be taken after a minimum of 10 to 15 minutes heating time.

PSG 6500 SERIES (with direct-vent)

- The positive pressure above the fire must be between .005 inch and .01 inch w.c. The pressure above the fire must be measured below the observation tube by removing the 5/16 nut intended for this use. **N.B. Do not forget to put the nut back in place.**
- The combustion air must be adjusted so that the smoke density is between 0 and 1 in the Bacharach test scale.
- The flue gases should contain 9 ½% to 12% CO₂ when tested with combustion test equipment.
- The positive pressure range in the gas evacuation pipe must be between .005 inch and .01 inch w.c. (measured 18" from the appliance gas evacuation outlet).

N.B. All those measurements must be taken after a minimum of 10 to 15 minutes heating time.

M- ELECTRODES SETTING

The electrodes setting should only be made by a competent technician. Correct electrodes positioning is important for efficient ignition of the oil spray.

ELECTRODES ADJUSTMENT FOR « F » HEAD

MODEL :

F0 @ F31
F30 @ F300

DIMENSION «N»

1/16"
1/8" – 5/32"

CAUTION

1. REFER TO THE NAME PLATE FOR PUMP PRESSURE AND NOZZLE SELECTION.
2. REFER TO BECKETT MANUAL FOR BECKETT PUMP DETAILS.
3. FOR ELECTRODES SETTING, SEE BECKETT MANUAL.
4. FOR STARTING AND ADJUSTING THE BURNER, REFER TO BURNER MANUAL.
5. IF THE BURNER FAILS, REFER TO BURNER MANUAL.

5- STARTING THE APPLIANCE

The start-up is usually performed by a qualified technician. Make sure the installation has been completed and the oil storage tank has been filled up. The pump system must also be purged.

The louvers located at the front of the appliance must be adjusted depending on the heat required in the room.

6- SHUT DOWN

- A) Turn electric switch at "Off".
- B) Close the oil shut-off valve.

NOTE : The shut-off valve (oil supply valve) must be kept closed if the burner is shut down for an extended period of time.

7- MAINTENANCE

The PSG-6500 SERIES appliance is one of the most efficient appliance in the heating industry. A proper maintenance will provide years of satisfaction. If required, call a qualified technician.

MAINTENANCE FREQUENCY

1. The unit, the burner and the flue pipe should be cleaned once a year.
2. The nozzle should be inspected and if necessary, changed. Handle nozzle with care so that inside surface is not scratched.
3. The electrodes should be adjusted as indicated in the burner manual.
4. Lubricate the motor bearings using two or three drops of SAE 20 lubricating oil, twice a year.
5. Lubricate with grease the two bearings of the fan motor, every two years (regular service).
6. The oil filter should be removed and changed annually.

CLOSING FOR SUMMER

During the summer months or whenever heat is not required for a considerate length of time, the unit electric circuit may be turned off.

CLEANING

N.B : ONLY A QUALIFIED SERVICE MAN SHOULD DO THE MAINTENANCE OF YOUR UNIT

At the beginning of the heating season, have the complete heating installation checked, especially the ignition system and control.

SERVICE

Before calling for service, first check the following :

1. Fuel supply
2. Electric fuses/breaker
3. Proper setting of room thermostat
4. Proper setting of limit control
5. Press reset button on combustion control and burner motor **One time only.**

Burner No.: _____ Model : _____ Date of installation : _____

Service telephone no.: _____ Day : _____ Night : _____

Dealer's name and address: _____

TEST REPORT:

Co2 _____% Temp. at stack: _____ Draught at stack: _____ w.c.

Nozzle : _____ GPH Smoke colour: _____

Inspected by : _____

CLEANING PROCEDURE

CAUTION : *Before cleaning, shut off electrical power supply to the appliance.*

Do not use any commercial soot remover

- 1- Take down the chimney flue pipe and remove soot that has accumulated inside.
- 2- Remove the soot that has accumulated inside the furnace flue pipe (if required).

- 3- Dismantle the burner and lay it down on a safe surface. Pay attention to the gasket.

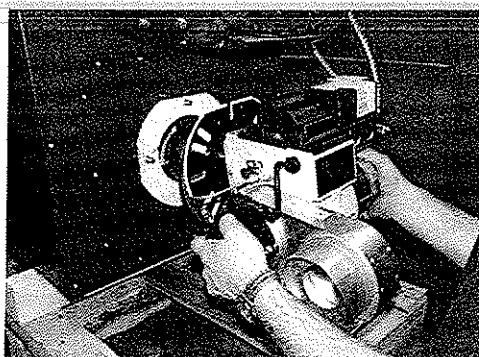
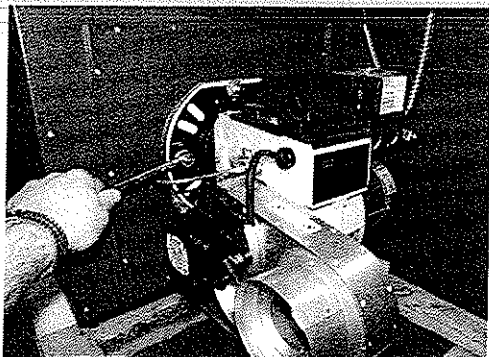

- 4- Remove the closing plate opposite the burner. Pay attention to the other gasket behind this plate.

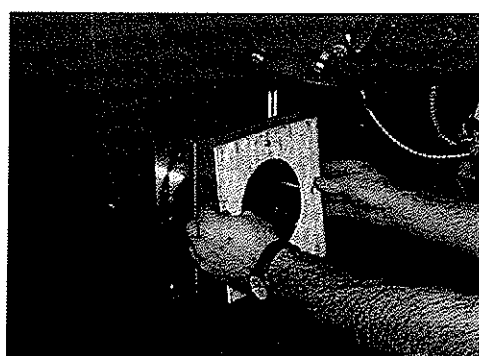
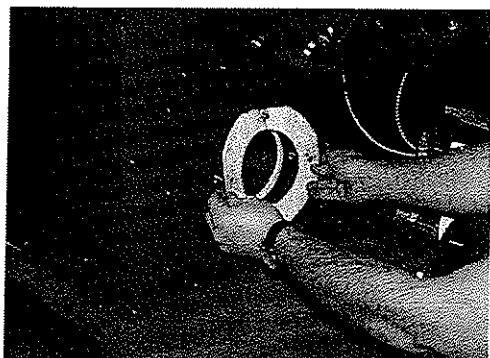

5- Loosen the retaining bolts of the combustion chamber support.

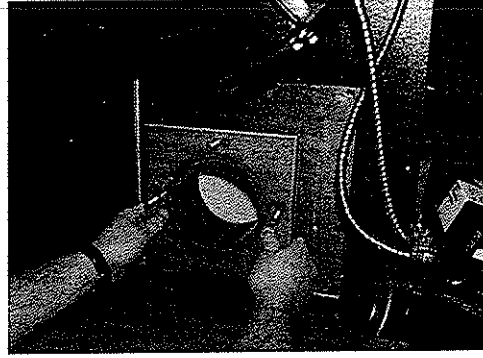
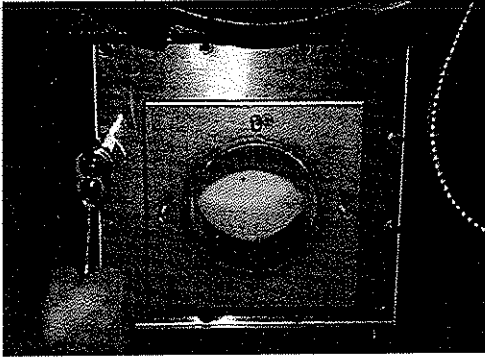

6- Remove with caution the combustion chamber with its support and put it down on a safe surface.

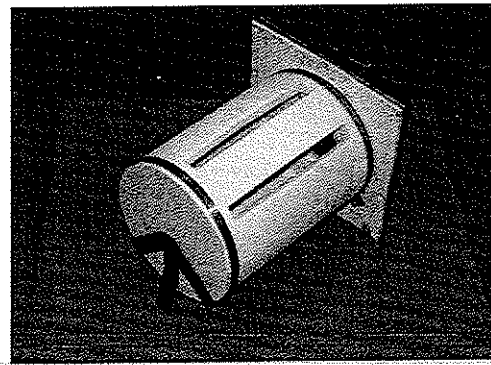
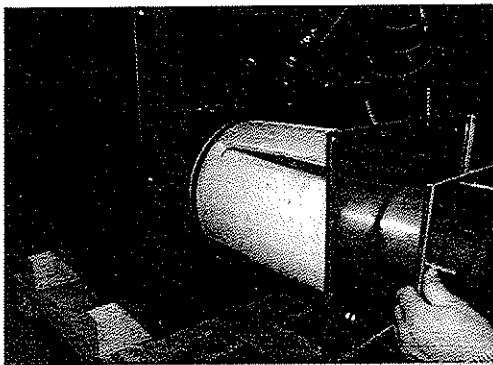
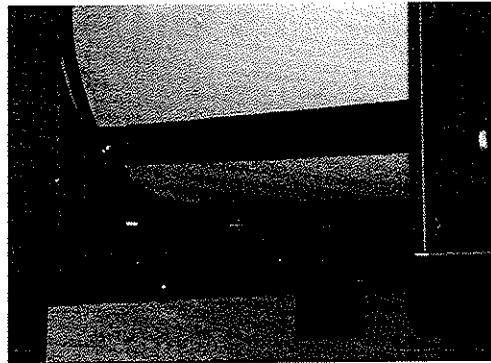
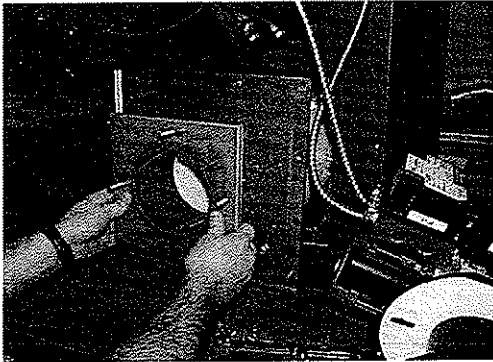

7- The qualified technician verifies the combustion chamber.

8*- If the technician considers that it is advisable to replace the combustion chamber and/or the gasket of the burner support he should proceed as follows.

N.B. It is important to remove completely the 2 straps before removing the combustion chamber out of its support because the 4 screws penetrate through the combustion chamber to keep it from rotating during transportation and heating periods. Then, if required, remove the combustion chamber support to replace the burner support gasket.

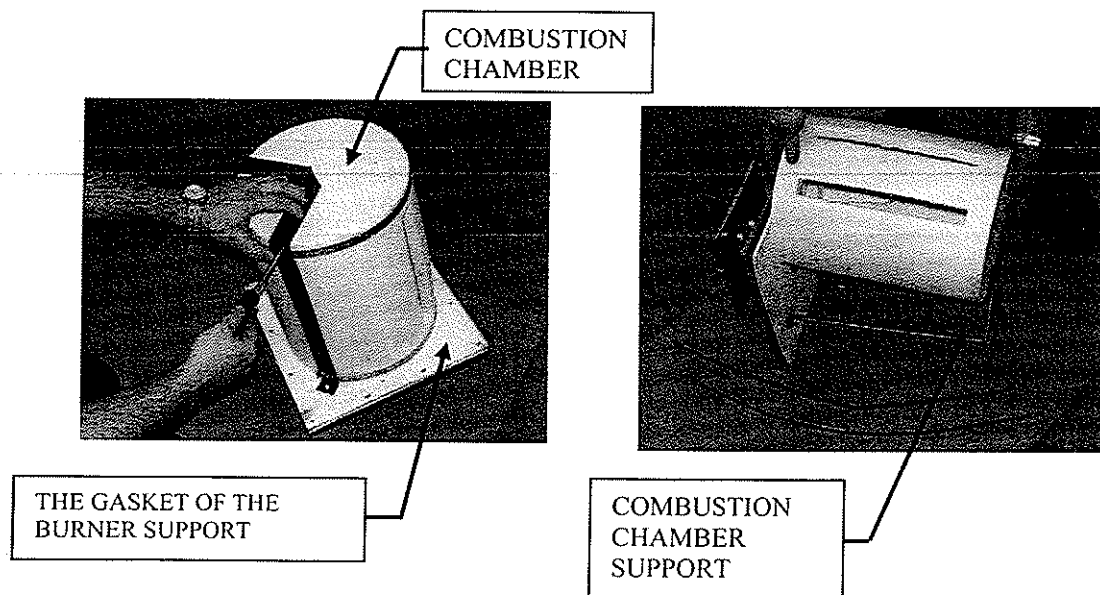

(Continuing the unit heater cleaning)

- 9- Brush all the inner parts of the unit and remove the soot (if necessary).
- 10- The technician reinstalls the combustion chamber with its gasket
- 11- Put the closing plate back in place with its gasket.
- 12- The technician cleans the burner head.
- 13- The technician takes down the electrodes to clean them, then replaces the nozzle and proceeds with the electrodes adjustment.
- 14- The technician reinstalls the burner
- 15- Reinstall the exhaust pipe.

* if necessary

8- WIRING DIAGRAM

NOTE : IF NECESSARY, A REPLACEMENT LIMIT CONTROL MUST BE IDENTICAL TO THAT SUPPLIED AS ORIGINAL EQUIPMENT.

DIAGRAMME DE FILAGE POUR PSG 6500 WIRING DIAGRAM FOR PSG 6500

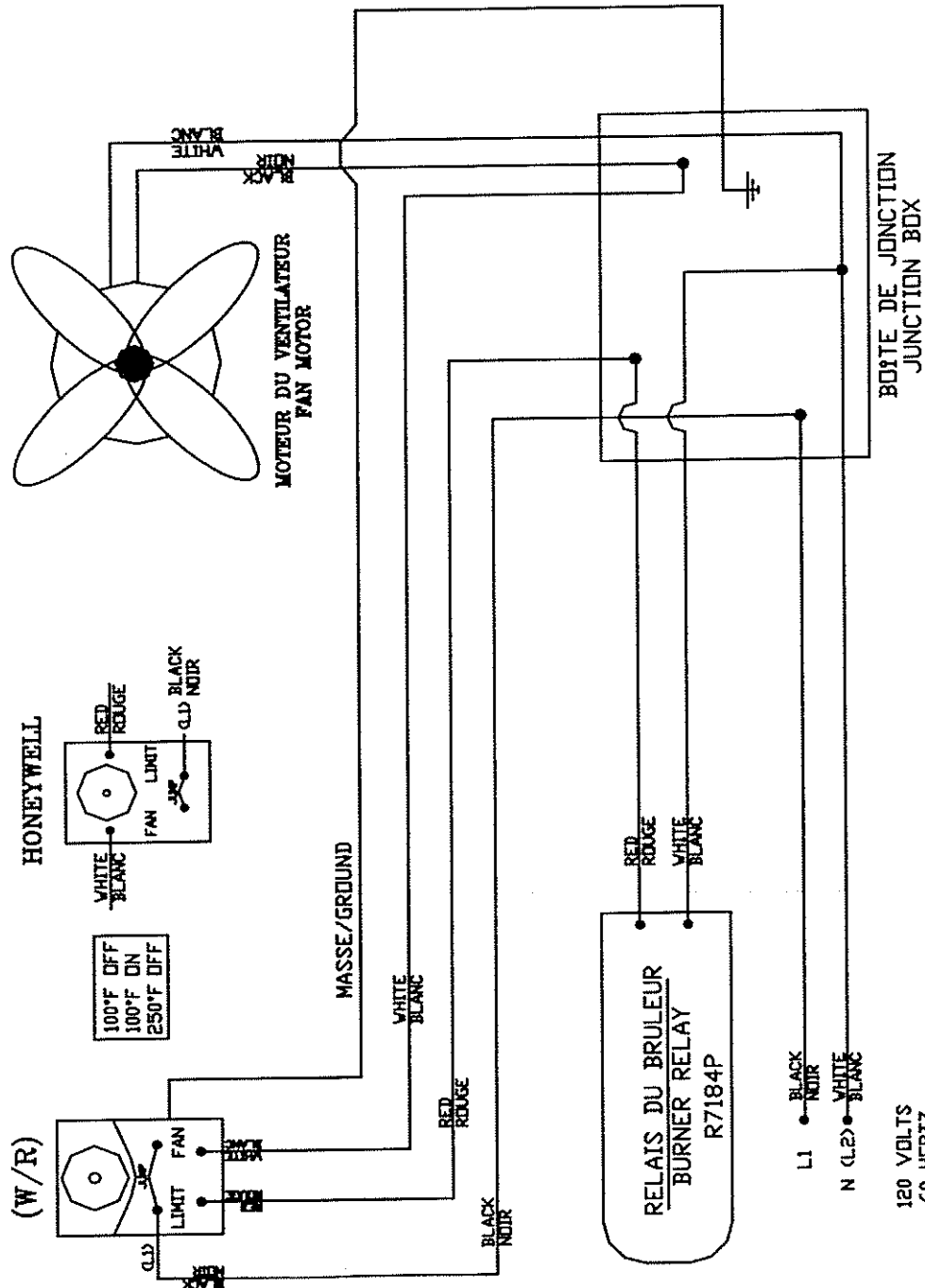

ADULT 2001
AUGUST

120 VOLTS
60 HERTZ

9- SPECIFICATIONS

Burner Model	BTU INPUT	Nozzle Dimension	Burner head	Static plate	Pressure at the pump	CFM	Motor RPM	H.P. motor
BECKETT AFG	90000	0.65 80 °W Delavan	F-0	3 3/8	100 lbs/sq.in.	1750	1075	1/6

PSG 6500 SERIES SPECIFICATIONS

1. INPUT (BTU/hr) : 90,000
2. OUTPUT (BTU/hr) : 75,060 (83.4%)
3. EXHAUST PIPE DIAMETER : 5"
4. FAN DIAMETER : 16"
5. NET WEIGHT : 190 lbs (86 KG)
6. FASTENERS : Height = 3" , ϕ = 7/8"

10- DIMENSIONS

WIDTH	20 _" (51.4 cm)	
DEPTH	35 _" (89.5cm) (without louvers)	37 _" (95.9cm) (with louvers)
HEIGHT	39 _" (99.7cm)	
DISTANCE FROM CENTER OF PIPE TO THE TOP	4"	

PSG LIMITED LIFETIME WARRANTY

The warranty of the manufacturer extends only to the original consumer purchaser and is not transferable. This warranty covers brand new products only, which have not been altered, modified nor repaired since shipment from factory. Proof of purchase (dated bill of sale), model name and serial number must be supplied when making any warranty claim to your PSG dealer.

This warranty applies to normal residential use only. Damages caused by misuse, abuse, improper installation, lack of maintenance, over firing, negligence or accident during transportation are not covered by this warranty.

This warranty does not cover any scratch, corrosion, warping, or discoloration caused by over firing, abrasives or chemical cleaners. Any defect or damage caused by the use of unauthorized parts or others than original parts void this warranty. An authorized qualified technician must perform the installation in accordance with the instructions supplied with this product and all local and national building codes. Any service call related to an improper installation is not covered by this warranty.

The manufacturer may require that defective products be returned or that digital pictures be provided to support the claim. Returned products are to be shipped prepaid to the manufacturer for investigation. If a product is found to be defective, the manufacturer will repair or replace such defect and reasonable transportation fees will be refunded. Repair work covered by the warranty, executed at the purchaser's domicile by an authorized qualified technician requires the prior approval of the manufacturer. Labour cost and repair work to the account of the manufacturer are based on predetermined rate schedule and must not exceed the wholesale price of the replacement part. All labour and freight costs covered by this warranty are limited according to the table below.

The manufacturer at its discretion may decide to repair or replace any part or unit after inspection and investigation of the defect. The manufacturer may, at its discretion, fully discharge all obligations with respect to this warranty by refunding the wholesale price of any warranted but defective parts. The manufacturer shall in no event be responsible for any special, indirect, consequential damages of any nature, which are in excess of the original purchase price of the product.

DESCRIPTION	WARRANTY APPLICATION	
	PARTS	LABOUR
Combustion chamber (welds only) and castings	Lifetime	5 years
Plating (defective manufacture) – subject to limitations above	Lifetime	n/a
Secondary air tubes, vermiculite baffle, C-Cast baffle and handle assembly	5 years	n/a
Stainless steel baffle and parts	5 years	3 years
Carbon steel baffle and parts	2 years	1 year
Oil burner, electrical elements, blowers, thermal switches, rheostat, relays, damper motor, fan & limit, and other controls	2 years	1 year
Paint (peeling), gaskets, insulation, and ceramic glass (thermal breakage only*)	1 year	n/a

**Pictures required*

Shall your unit or a components be defective, contact immediately your PSG dealer. Prior to your call make sure you have the following information necessary to your warranty claim treatment:

- Your name, address and telephone number;
- Bill of sale and dealer's name;
- Serial number and model name as indicated on the nameplate fixed to the back of your unit;
- Nature of the defect and any relevant information.

Before shipping your unit or defective component to our plant, you must obtain from your PSG dealer an Authorization Number. Any merchandise shipped to our plant without authorization will be refused automatically and returned to sender.